

FLUKE®

724

Temperature Calibrator

Product Overview

English

February 2000

© 2000 Fluke Corporation. All rights reserved. Printed in U.S.A.
All product names are trademarks of their respective companies.

Accessing the Users Manual

The *724 Temperature Calibrator Users Manual* is available on the 724 CD included with your calibrator.

Contacting Fluke

To order accessories, receive operating assistance, or get the location of the nearest Fluke distributor or Service Center, call:

USA: 1-888-99-FLUKE (1-888-993-5853)

Canada: 1-800-363-5853

Europe: +31 402-678-200

Japan: +81-3-3434-0181

Singapore: +65-738-5655

Anywhere in the world: +1-425-356-5500

Or, visit Fluke's Web site at www.fluke.com.

Temperature Calibrator

Introduction

Your Fluke 724 Temperature Calibrator is a handheld, battery-operated instrument that measures and sources a variety of thermocouples and RTDs. See Table 1.

In addition to the functions in Table 1, the calibrator has the following features and functions:

- A split-screen display. The upper display allows you to measure volts, current. The lower display allows you to measure and source volts, resistance temperature detectors, thermocouples, and ohms.
- A thermocouple (TC) input/output terminal and internal isothermal block with automatic reference-junction temperature compensation.
- Storage and recall of 8 setups.
- Manual stepping and automatic stepping and ramping.

Table 1. Summary of Source and Measure Functions

Function	Measure	Source
dc V	0 V to 30 V	0 V to 10 V
Resistance	0 Ω to 3200 Ω	15 Ω to 3200 Ω
Thermocouple	Types E, J, K, T, B, R, S, L, U, N, mV	
RTD (Resistance- Temperature Detector)	Pt100 Ω (385) Pt100 Ω (3926) Pt100 Ω (3916) Pt200 Ω (385) Pt500 Ω (385) Pt1000 Ω (385) Ni120	
Other functions	Loop supply, Step, Ramp, Memory, Dual display	

Standard Equipment

The items listed below are included with your calibrator. If the calibrator is damaged or something is missing, contact the place of purchase immediately. To order replacement parts or spares, see the user-replaceable parts list near the end of this manual.

- TL75 test leads (one set)
- Alligator clips (one set)
- Stackable alligator clip test leads (one set)
- *724 Product Overview Manual*
- *724 CD-ROM* (contains Users Manual)

Safety Information

The calibrator is designed in accordance with IEC1010-1, ANSI/ISA S82.01-1994 and CAN/CSA C22.2 No. 1010.1-92. Use the calibrator only as specified in this manual, otherwise the protection provided by the calibrator may be impaired.

A **Warning** identifies conditions and actions that pose hazard(s) to the user; a **Caution** identifies conditions and actions that may damage the calibrator or the equipment under test.

International symbols used on the calibrator and in this manual are explained in Table 2.

Warning

To avoid possible electric shock or personal injury:

- **Do not apply more than the rated voltage, as marked on the calibrator, between the terminals, or between any terminal and earth ground. Maximim for all terminals is 30 V, 24 mA.**
- **Before each use, verify the calibrator's operation by measuring a known voltage.**
- **Follow all equipment safety procedures.**
- **Never touch the probe to a voltage source when the test leads are plugged into the current terminals.**
- **Do not use the calibrator if it is damaged. Before you use the calibrator, inspect the case. Look for cracks or missing plastic. Pay particular attention to the insulation surrounding the connectors.**
- **Select the proper function and range for your measurement.**
- **Make sure the battery door is closed and latched before you operate the calibrator.**
- **Remove test leads from the calibrator before you open the battery door.**
- **Inspect the test leads for damaged insulation or exposed metal. Check test leads continuity. Replace damaged test leads before you use the calibrator.**

⚠ Warning











- When using the probes, keep your fingers away from the probe contacts. Keep your fingers behind the finger guards on the probes.
- Connect the common test lead before you connect the live test lead. When you disconnect test leads, disconnect the live test lead first.
- Do not use the calibrator if it operates abnormally. Protection may be impaired. When in doubt, have the calibrator serviced.
- Do not operate the calibrator around explosive gas, vapor, or dust.
- Use only 4 AA batteries, properly installed in the calibrator case, to power the calibrator.
- Disconnect test leads before changing to another measure or source function.
- When servicing the calibrator, use only specified replacement parts.
- To avoid false readings, which could lead to possible electric shock or personal injury, replace the batteries as soon as the battery indicator (⊕) appears.

Caution

To avoid possible damage to calibrator or to equipment under test:

- Disconnect the power and discharge all high-voltage capacitors before testing resistance or continuity.
- Use the proper jacks, function, and range for your measurement or sourcing application.

Table 2. International Symbols

	AC - Alternating current		Double insulated
	DC - Direct current		Battery
	Earth ground		Refer to the manual for information about this feature.
	Pressure		ON/OFF
	Conforms to Canadian Standards Association directives		Conforms to European Union directives

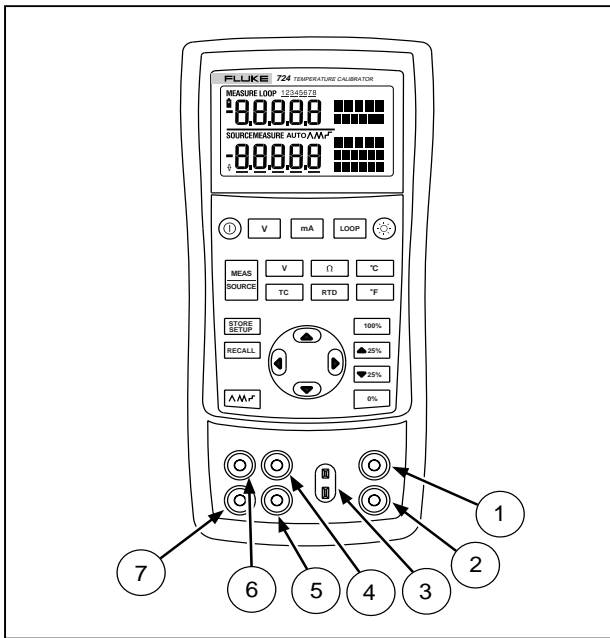

zi02f.eps

Figure 1. Input/Output Terminals and Connectors

Table 3. Input/Output Terminals and Connectors

No	Name	Description
①, ②	MEASURE V, mA terminals	Input terminals for measuring voltage, current, and supplying loop power.
③	TC input/output	Terminal for measuring or simulating thermocouples. This terminal accepts a miniature polarized thermocouple plug with flat, in-line blades spaced 7.9 mm (0.312 in) center to center.
④, ⑤	SOURCE/ MEASURE V, RTD, Ω terminals	Terminals for sourcing or measuring voltage, resistance, and RTDs.
⑥, ⑦	MEASURE 3W, 4W	Terminals for performing 3W and 4W RTD measurements.

Keys

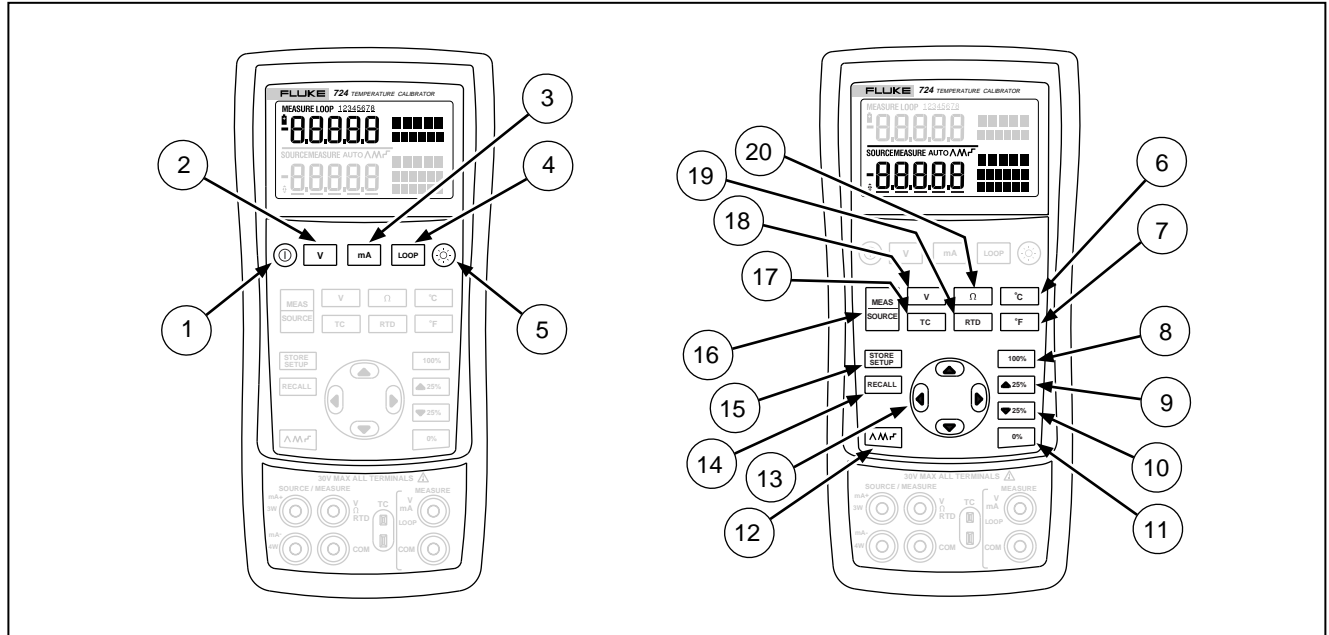

Figure 2. Keys

zi03f.eps

Table 4. Key Functions





















No	Name	Description
①		Turns the power on or off.
②		Selects voltage measurement function in the upper display.
③		Selects the mA measurement function in the upper display.
④		Activates a 24-volt loop supply while measuring mA.
⑤		Turns backlight on or off.
⑥		Displays temperature in degrees Celsius when in TC or RTD functions.
⑦		Displays temperature in degrees Fahrenheit when in TC or RTD functions.
⑧		Recalls from memory a source value corresponding to 100 % of span and sets it as the source value. Press and hold to store any source value as the 100 % value.
⑨		Increments output by 25 % of span.
⑩		Decrements output by 25 % of span.
⑪		Recalls from memory a source value corresponding to 0 % of span and sets it as the source value. Press and hold to store the source value as the 0 % value.

Table 4. Key Functions (cont.)

No	Name	Description
12		<p>Cycles through :</p> <p>∧ Slow repeating 0 % - 100 % - 0 % ramp</p> <p>∧∧ Fast repeating 0 % - 100 % - 0 % ramp</p> <p>┌┐ Repeating 0 % - 100 % - 0 % ramp in 25 % steps</p>
13		<p>Increases or decreases the source level.</p> <p>Cycles through the 2-, 3-, and 4-wire selections.</p> <p>Moves through the eight memory locations of calibrator setups.</p>
14		Retrieves a previous calibrator setup from one of eight memory locations.
15		Saves the calibrator setup to one of eight memory locations.
16		Cycles the calibrator through MEASURE and SOURCE modes in the lower display.
17		Selects TC (thermocouple) measurement and sourcing function in the lower display. Repeated pushes cycle through the thermocouple types.
18		Toggles between voltage, sourcing, and measuring functions in the lower display.
19		Selects RTD (resistance temperature detector) measurement and sourcing function in lower display. Repeated pushes cycle through the RTD types.
20		Selects the ohms measurement and sourcing function.

Display

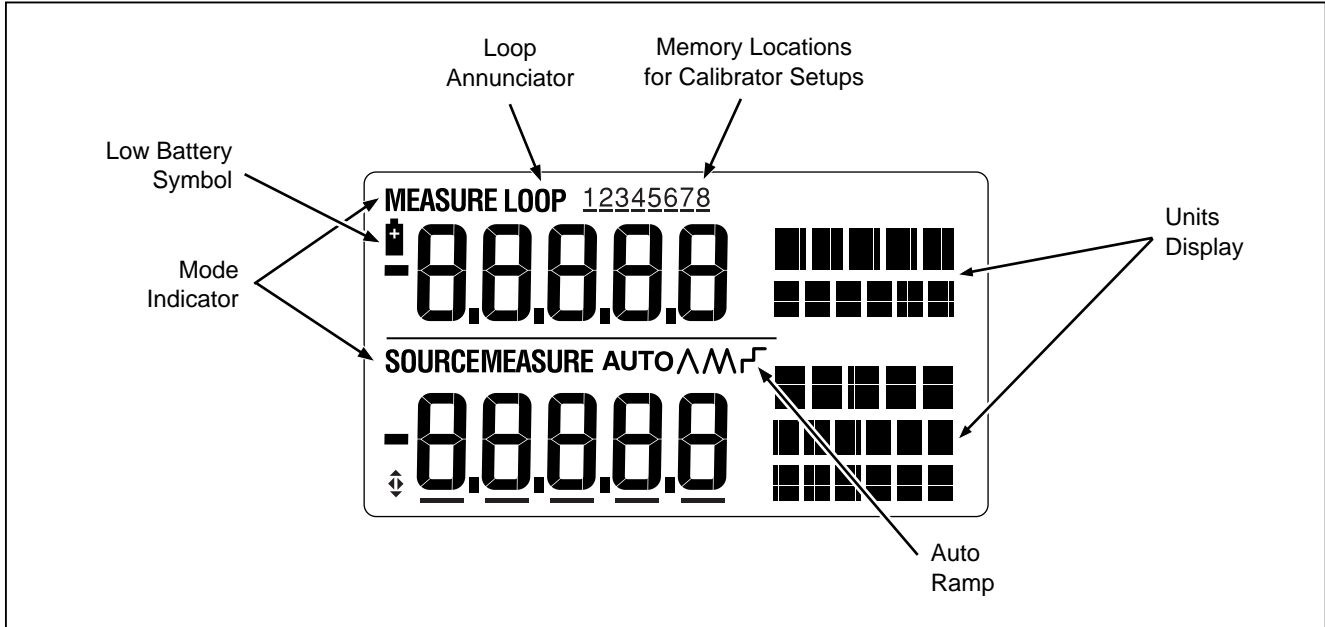

Figure 3. Elements of a Typical Display

sh07f.eps

Replacing the Batteries

Warning

To avoid false readings, which could lead to possible electric shock or personal injury, replace the batteries as soon as the battery indicator (🔋) appears.

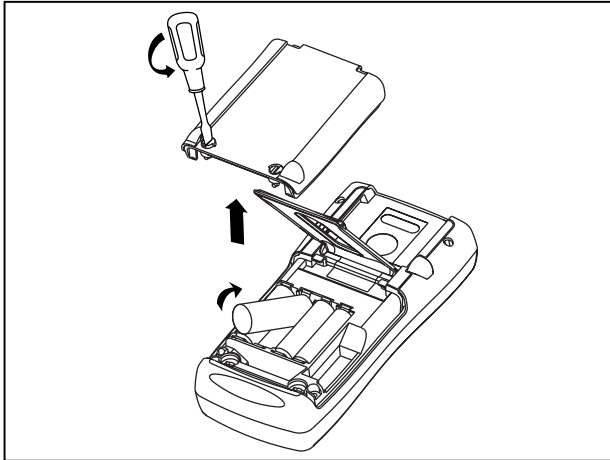

sh38f.eps

Figure 4. Replacing the Batteries

Replacement Parts

Item	Description	PN	Qty.
1	Case top	664232	1
2	LCD mask	1548383	1
3	Elastomeric strips	690883	2
4	Input/output bracket	1549221	1
5	LCD bracket	658390	1
6	Mounting screws	494641	11
7	Backlight	690336	1
8	LCD	690963	1
9	Keypad	1548126	1
10	Case bottom	664235	1
11	AA alkaline batteries	376756	4
12	Case screws	832246	4
13	Battery door	664250	1
14	Accessory mount	658424	1
15	Tilt stand	659026	1
16	Battery door 1/4-turn fasteners	948609	2
17	TL75 series test leads	855742	1
18	Test lead, red	688051	1
	Test lead, black	688066	1
19	724 Product Overview Manual	1547851	1
20	AC70A alligator clip, red	738047	1
	AC70A alligator clip, black	738120	1
21	CD-ROM (includes the 724 Users Manual)	1547849	1
22	Top case decal	1548329	1

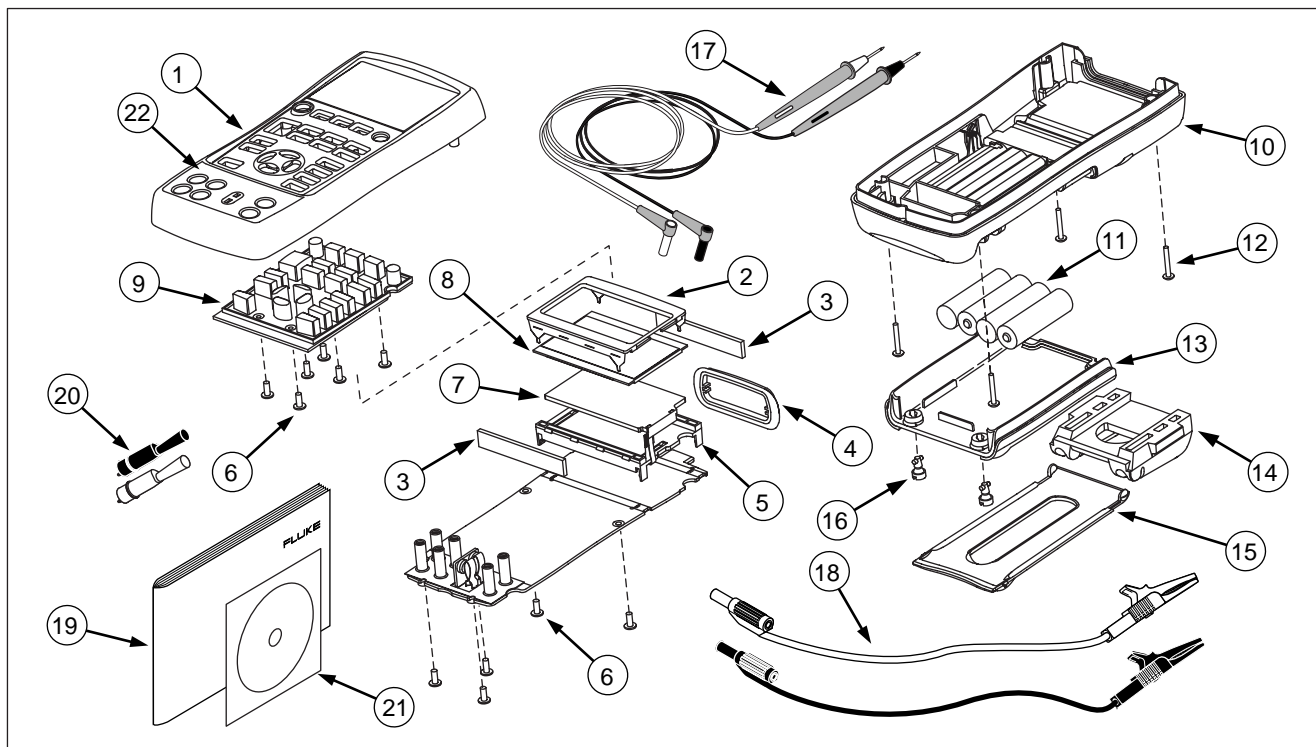

Figure 5. Replacement Parts

zi45f.eps

Specifications

All specifications apply from +18 °C to +28 °C unless stated otherwise. All specifications assume a 5-minute warmup period. Temperature coefficient from -10 °C to 18 °C and +28 °C to 55 °C is $\pm 0.005\%$ of range per °C.

Voltage and Current Functions

Range	Resolution	Accuracy (% Reading + Counts)
DC Voltage Measurement		
30 V (upper display)	0.001 V	0.02 % + 2
20 V (lower display)	0.001 V	0.02 % + 2
90 mV	0.01 mV	0.02 % + 2
DC Voltage Source (Maximum load: 1 mA)		
100 mV	0.01 mV	0.02 % + 2
10 V	0.001 V	0.02 % + 2
DC mA Measurement (Drive capability: 1000 Ω at 20 mA)		
24 mA	0.001 mA	0.02 % + 2
Millivolt Measurement and Source* (Maximum input: 30 V)		
-10 mV to 75 mV	0.01 mV	$\pm(0.025\% + 1 \text{ count})$

* Select this function by pressing . The signal is available at the thermocouple miniplug connector.

Ohms Measurement

Ohms Range	Accuracy $\pm \Omega^*$	
	4-Wire	2- and 3-Wire
0 to 400 Ω	0.1	0.15
400 to 1.5 k Ω	0.5	1.0
1.5 to 3.2 k Ω	1	1.5

Excitation current: 0.2 mA
Maximum input voltage: 30 V

* 2-wire: Does not include lead resistance.
3-wire: Assumes matched leads with a total resistance not exceeding 100 Ω .

Ohms Source

Ohms Range	Excitation Current from Measurement Device	Accuracy $\pm \Omega$
15 to 400 Ω	0.15 to 0.5 mA	0.15
15 to 400 Ω	0.5 to 2 mA	0.1
400 to 1.5 k Ω	0.05 to 0.8 mA	0.5
1.5 to 3.2 k Ω	0.05 to 0.4 mA	1
Resolution		
15 to 400 Ω	0.1 Ω	
400 to 3.2 k Ω	1 Ω	

Temperature, Thermocouples

Type	Range	Measure and Source Accuracies
J	-200 to 0 °C	1.0 °C
	1200 °C	0.7 °C
K	-200 to 0 °C	1.2 °C
	0 to 1370 °C	0.8 °C
T	-200 to 0 °C	1.2 °C
	0 to 400 °C	0.8 °C
E	-200 to 0 °C	0.9 °C
	0 to 950 °C	0.7 °C
R	-20 to 0 °C	2.5 °C
	0 to 500 °C	1.8 °C
	500 to 1750 °C	1.4 °C
S	-20 to 0 °C	2.5 °C
	0 to 500 °C	1.8 °C
	500 to 1750 °C	1.5 °C

Type	Range	Measure and Source Accuracies
B	600 to 800 °C	2.2 °C
	800 to 1000 °C	1.8 °C
	1000 to 1800 °C	1.4 °C
L	-200 to 0 °C	0.85 °C
	0 to 900 °C	0.7 °C
U	-200 to 0 °C	1.1 °C
	0 to 400 °C	0.75 °C
N	-200 to 0 °C	1.5 °C
	0 to 1300 °C	0.9 °C
Resolution:		
J, K, T, E, L, N, U:		0.1 °C, 0.1 °F
B, R, S:		1 °C, 1 °F

Temperature, RTD Ranges, and Accuracies

Type	Range °C	Accuracy °C		
		Measure 4-Wire	Measure 2- and 3-Wire*	Source
Ni120	-80 to 260	0.2	0.3	0.2
Pt100-385	-200 to 800	0.33	0.5	0.33
Pt100-392	-200 to 630	0.3	0.5	0.3
Pt100-JIS	-200 to 630	0.3	0.5	0.3
Pt200-385	-200 to 250	0.2	0.3	0.2
	250 to 630	0.8	1.6	0.8
Pt500-385	-200 to 500	0.3	0.6	0.3
	500 to 630	0.4	0.9	0.4
Pt1000-385	-200 to 100	0.2	0.4	0.2
	100 to 630	0.2	0.5	0.2

Resolution: 0.1 °C, 0.1 °F
Allowable excitation current (source): Ni120, Pt100-385, Pt100-392, Pt100-JIS, Pt200-385: 0.15 to 3.0 mA
Pt500-385: 0.05 to 0.80 mA; Pt1000-385: 0.05 to 0.40 mA
RTD Source: Addresses pulsed transmitters and PLCs with pulses as short as 5 ms.
* 2-wire: Does not include lead resistance. 3-wire: Assumes matched leads with a total resistance not exceeding 100 Ω.

General Specifications

Operating temperature	-10 °C to 55 °C
Storage temperature	- 20 °C to 71 °C
Operating altitude	3000 meters above mean sea level
Relative Humidity (% RH operating without condensation)	90 % (10 to 30 °C) 75 % (30 to 40 °C) 45 % (40 to 50 °C) 35 % (50 to 55 °C) uncontrolled < 10 °C
Vibration	Random, 2 g, 5 to 500 Hz
Safety	EN 61010-1:1993, ANSI/ISA S82.01-1994; CAN/CSA C22.2 No 1010.1:1992
Power requirements	4 AA alkaline batteries
Size	96 x 200 x 47 mm (3.75 x 7.9 x 1.86 in)
Weight	650 gm (1 lb, 7 oz)

Loop Power Supply

Voltage: 24 V
Maximum current: 22 mA
Short circuit protected

LIMITED WARRANTY & LIMITATION OF LIABILITY

Each Fluke product is warranted to be free from defects in material and workmanship under normal use and service. The warranty period is three years and begins on the date of shipment. Parts, product repairs and services are warranted for 90 days. This warranty extends only to the original buyer or end-user customer of a Fluke authorized reseller, and does not apply to fuses, disposable batteries or to any product which, in Fluke's opinion, has been misused, altered, neglected, contaminated, or damaged by accident or abnormal conditions of operation or handling. Fluke warrants that software will operate substantially in accordance with its functional specifications for 90 days and that it has been properly recorded on non-defective media. Fluke does not warrant that software will be error free or operate without interruption.

Fluke authorized resellers shall extend this warranty on new and unused products to end-user customers only but have no authority to extend a greater or different warranty on behalf of Fluke. Warranty support is available only if product is purchased through a Fluke authorized sales outlet or Buyer has paid the applicable international price. Fluke reserves the right to invoice Buyer for importation costs of repair/replacement parts when product purchased in one country is submitted for repair in another country.

Fluke's warranty obligation is limited, at Fluke's option, to refund of the purchase price, free of charge repair, or replacement of a defective product which is returned to a Fluke authorized service center within the warranty period.

To obtain warranty service, contact your nearest Fluke authorized service center to obtain return authorization information, then send the product to that service center, with a description of the difficulty, postage and insurance prepaid (FOB Destination). Fluke assumes no risk for damage in transit. Following warranty repair, the product will be returned to Buyer, transportation prepaid (FOB Destination). If Fluke determines that failure was caused by neglect, misuse, contamination, alteration, accident or abnormal condition of operation or handling, including overvoltage failures caused by use outside the product's specified rating, or normal wear and tear of mechanical components, Fluke will provide an estimate of repair costs and obtain authorization before commencing the work. Following repair, the product will be returned to the Buyer transportation prepaid and the Buyer will be billed for the repair and return transportation charges (FOB Shipping Point).

THIS WARRANTY IS BUYER'S SOLE AND EXCLUSIVE REMEDY AND IS IN LIEU OF ALL OTHER WARRANTIES, EXPRESS OR IMPLIED, INCLUDING BUT NOT LIMITED TO ANY IMPLIED WARRANTY OF MERCHANTABILITY OR FITNESS FOR A PARTICULAR PURPOSE. FLUKE SHALL NOT BE LIABLE FOR ANY SPECIAL, INDIRECT, INCIDENTAL OR CONSEQUENTIAL DAMAGES OR LOSSES, INCLUDING LOSS OF DATA, ARISING FROM ANY CAUSE OR THEORY.

Since some countries or states do not allow limitation of the term of an implied warranty, or exclusion or limitation of incidental or consequential damages, the limitations and exclusions of this warranty may not apply to every buyer. If any provision of this Warranty is held invalid or unenforceable by a court or other decision-maker of competent jurisdiction, such holding will not affect the validity or enforceability of any other provision.

Fluke Corporation
P.O. Box 9090
Everett, WA 98206-9090
U.S.A.

Fluke Europe B.V.
P.O. Box 1186
5602 BD Eindhoven
The Netherlands